

STONEAGE<sup>®</sup>



PRODUCTIONS

architectural cast stone

# *Columns & Pilasters*

Stock Profile Collection







**STONEAGE**  
architectural cast stone

**Profile Index  
and Quick Order Form**

**Columns**

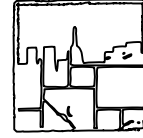

**CITY  
LIMESTONE**  
limestone fabricators

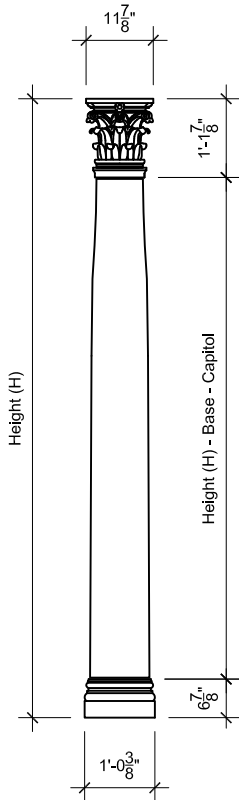

Column can be assembled with the post.

COLUMN 1

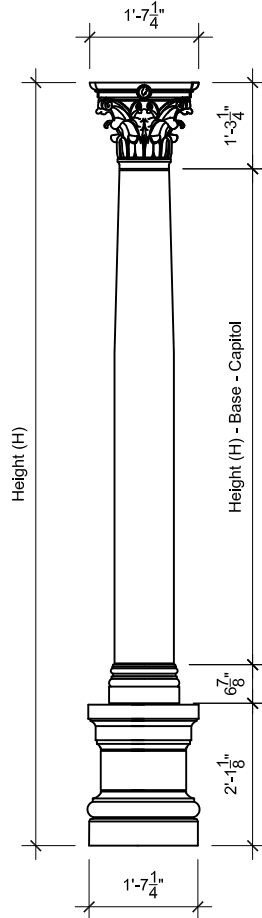

The post is optional. Dimensions of the post are adjusted to the total height of the column.

COLUMN 2

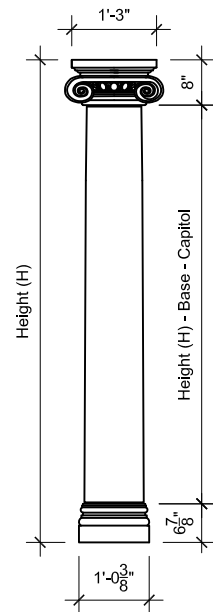

Column can be assembled with the post.

COLUMN 3

*Quick Order Table*

Height (H)

Post (Yes/No)

Qty

**Column #**

You can place your order by faxing or e-mailing a scanned version of this form to (718) 486-9105. If you have any questions please contact us at (718) 703-0007.

Material or color choice:

Natural limestone choice or cast stone color

All columns can be combined with the post. Dimensions of the post are adjusted to the size of the whole column. Posts can be also designed using different moldings than you can see on the following drawings. Please contact our office about placing an order if you have any concerns and / or if your order includes the post.

Index page 1

1117 38<sup>th</sup> Street Brooklyn, NY 11218 Tel.: (718) 703 0007 Fax: (718) 486 9105 www.stoneage.net info@stoneage.net 400 Federal Blvd Carteret, NJ 07008 Tel.: (732) 750 3090 Fax: (732) 750 3095 www.citylimestone.com info@citylimestone.com



**STONEAGE**  
architectural cast stone

**Profile Index  
and Quick Order Form**

*Columns*

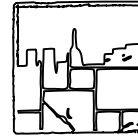

**CITY  
LIMESTONE**  
limestone fabricators

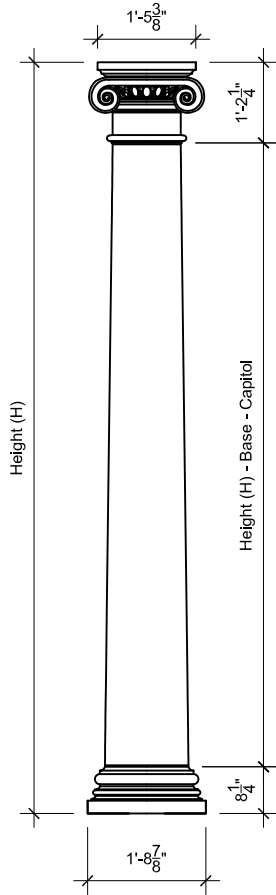

Column can be assembled with the post.

COLUMN 4

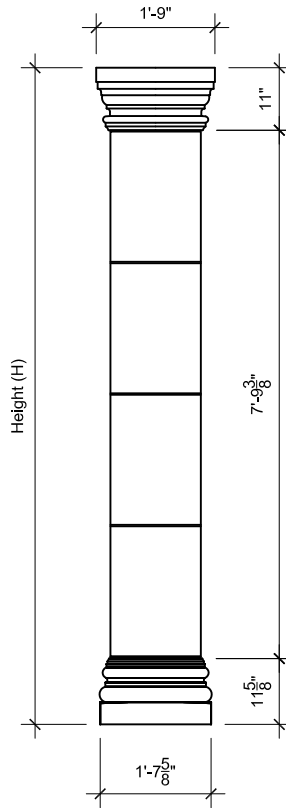

Column can be assembled with the post.

COLUMN 5

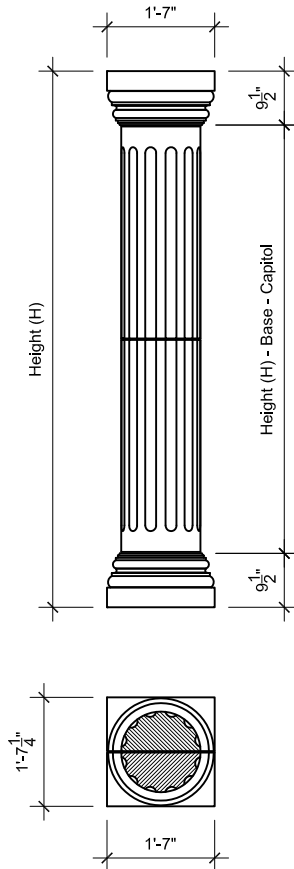

Column can be assembled with the post.

COLUMN 6

Quick Order Table	Height (H)	Post (Yes/No)	Qty

<b>Column #</b>	<p>You can place your order by faxing or e-mailing a scanned version of this form to (718) 486-9105. If you have any questions please contact us at (718) 703-0007.</p>	<p>Material or color choice:</p> <p>_____</p> <p>Natural limestone choice or cast stone color</p>

All columns can be combined with the post. Dimensions of the post are adjusted to the size of the whole column. Posts can be also designed using different moldings than you can see on the following drawings. Please contact our office about placing an order if you have any concerns and / or if your order includes the post.

Index page 2

1117 38 <sup>th</sup> Street Brooklyn, NY 11218	Tel.: (718) 703 0007 Fax: (718) 486 9105	www.stoneage.net info@stoneage.net	400 Federal Blvd Carteret, NJ 07008	Tel.: (732) 750 3090 Fax: (732) 750 3095	www.citylimestone.com info@citylimestone.com
--	---	---------------------------------------	--	---	---



**STONEAGE**  
architectural cast stone

**Profile Index  
and Quick Order Form**

*Columns*

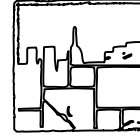

**CITY  
LIMESTONE**  
limestone fabricators

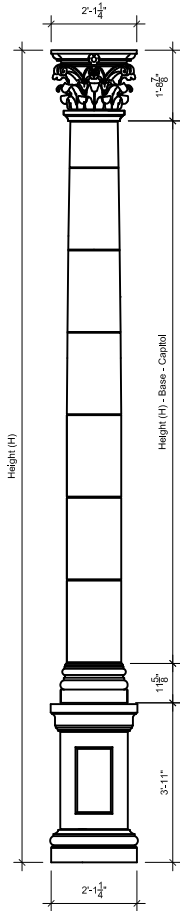

COLUMN 7

*Quick Order Table*

Height (H)

Post (Yes/No)

Qty

**Column #**

You can place your order by faxing or e-mailing a scanned version of this form to (718) 486-9105. If you have any questions please contact us at (718) 703-0007.

Material or color choice:

\_\_\_\_\_  
Natural limestone choice  
or cast stone color

All columns can be combined with the post. Dimensions of the post are adjusted to the size of the whole column. Posts can be also designed using different moldings than you can see on the following drawings. Please contact our office about placing an order if you have any concerns and / or if your order includes the post.

Index page 3

1117 38<sup>th</sup> Street  
Brooklyn, NY 11218

Tel.: (718) 703 0007  
Fax: (718) 486 9105

www.stoneage.net  
info@stoneage.net

400 Federal Blvd  
Carteret, NJ 07008

Tel.: (732) 750 3090  
Fax: (732) 750 3095

www.citylimestone.com  
info@citylimestone.com



**STONEAGE**  
architectural cast stone

**Profile Index  
and Quick Order Form**

*Pilasters*

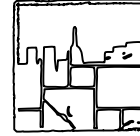

**CITY  
LIMESTONE**  
limestone fabricators

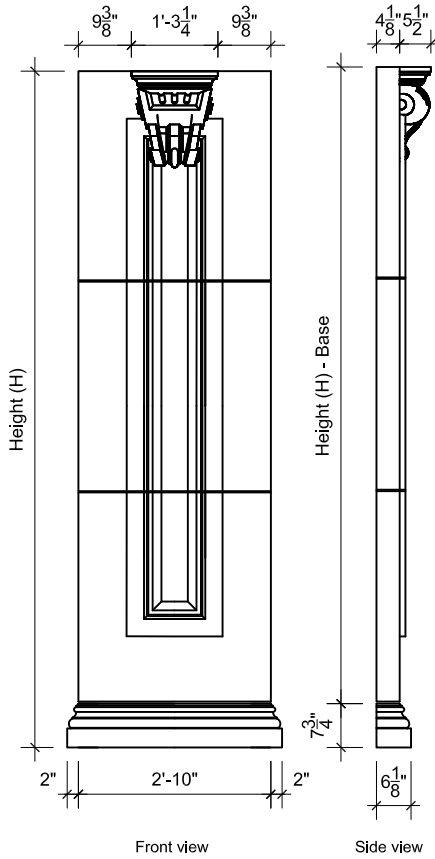

PILASTER 1

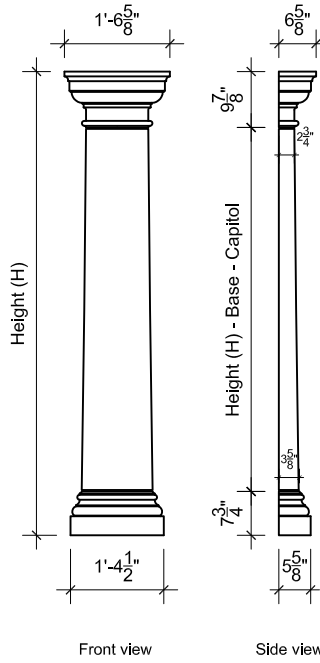

PILASTER 2

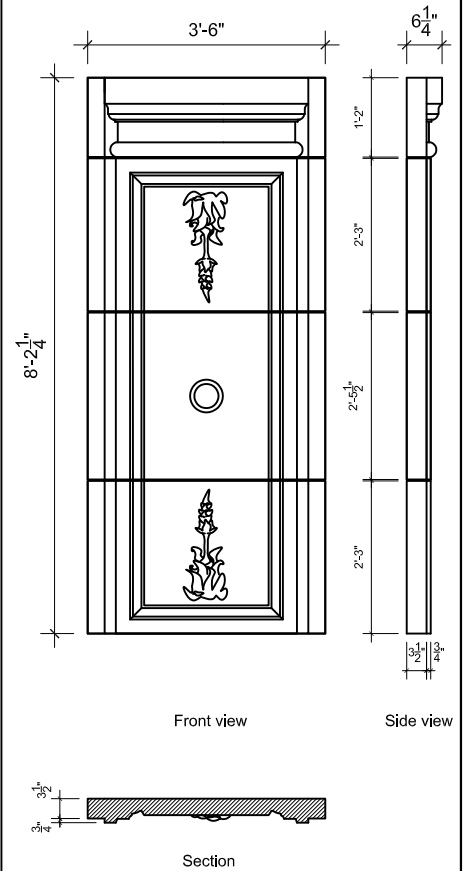

PILASTER 3

*Quick Order Table*

Height (H)

Qty

Note

**Pilaster #**

You can place your order by faxing or e-mailing a scanned version of this form to (718) 486-9105. If you have any questions please contact us at (718) 703-0007.

Material or color choice:

Natural limestone choice  
or cast stone color

Index page 1

1117 38<sup>th</sup> Street  
Brooklyn, NY 11218

Tel.: (718) 703 0007  
Fax: (718) 486 9105

www.stoneage.net  
info@stoneage.net

400 Federal Blvd  
Carteret, NJ 07008

Tel.: (732) 750 3090  
Fax: (732) 750 3095

www.citylimestone.com  
info@citylimestone.com



**STONEAGE**  
architectural cast stone

**Profile Index  
and Quick Order Form**

*Pilasters*

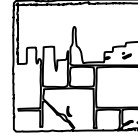

**CITY  
LIMESTONE**  
limestone fabricators

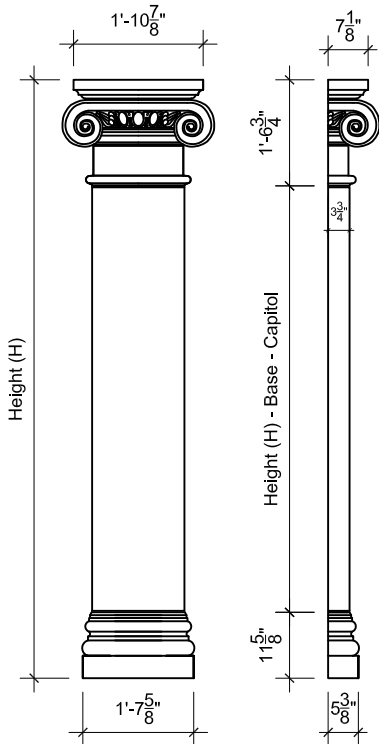

Front view

Side view

PILASTER 4

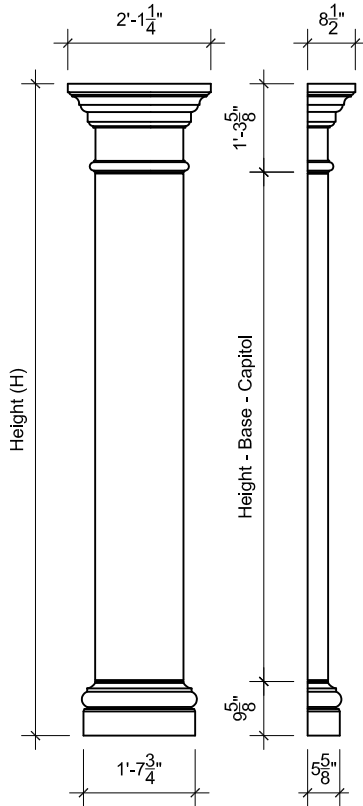

Front view

Side view

PILASTER 5

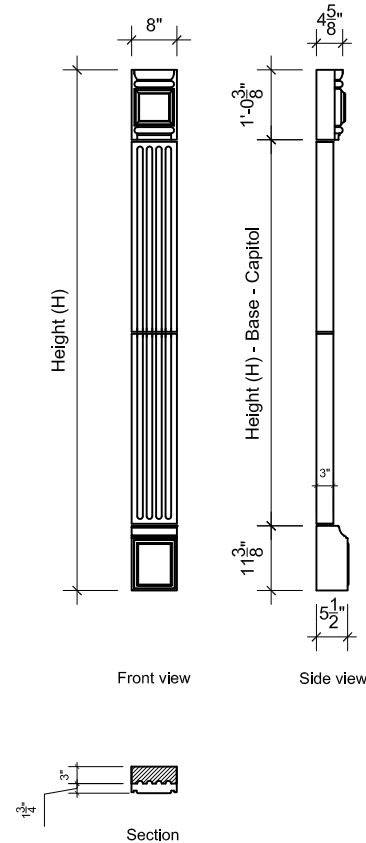

Front view

Side view

Section

PILASTER 6

*Quick Order Table*

Height (H)

Qty

Note

**Pilaster #**

You can place your order by faxing or e-mailing a scanned version of this form to (718) 486-9105. If you have any questions please contact us at (718) 703-0007.

Material or color choice:

Natural limestone choice  
or cast stone color

Index page 2

1117 38<sup>th</sup> Street  
Brooklyn, NY 11218

Tel.: (718) 703 0007  
Fax: (718) 486 9105

www.stoneage.net  
info@stoneage.net

400 Federal Blvd  
Carteret, NJ 07008

Tel.: (732) 750 3090  
Fax: (732) 750 3095

www.citylimestone.com  
info@citylimestone.com



**STONEAGE**  
architectural cast stone

**Profile Index  
and Quick Order Form**

*Pilasters*

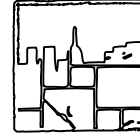

**CITY  
LIMESTONE**  
limestone fabricators

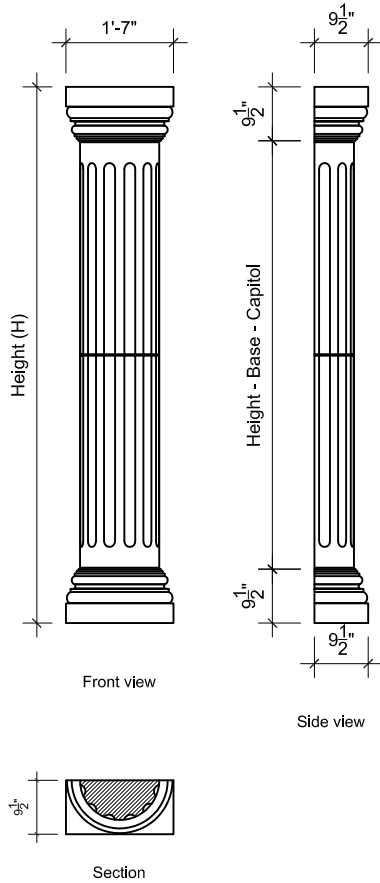

PILASTER 7

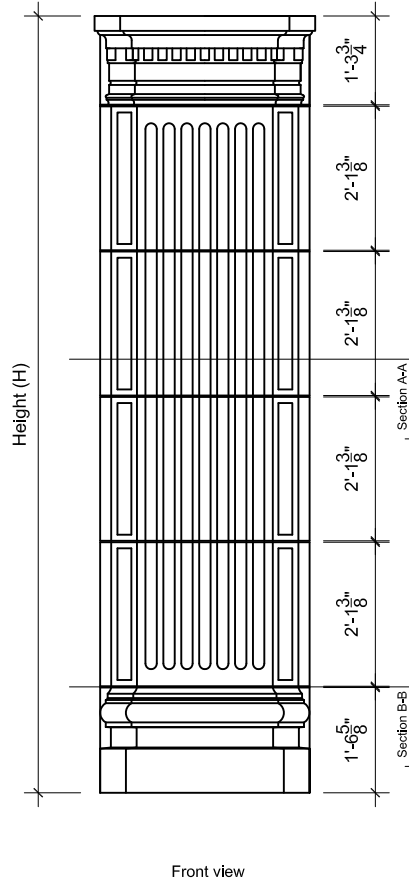

PILASTER 8

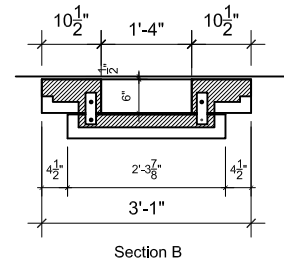
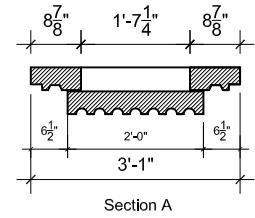

*Quick Order Table*

Height (H)

Qty

Note

**Pilaster #**

You can place your order by faxing or e-mailing a scanned version of this form to (718) 486-9105. If you have any questions please contact us at (718) 703-0007.

Material or color choice:

Natural limestone choice  
or cast stone color

Index page 3

1117 38<sup>th</sup> Street  
Brooklyn, NY 11218

Tel.: (718) 703 0007  
Fax: (718) 486 9105

www.stoneage.net  
info@stoneage.net

400 Federal Blvd  
Carteret, NJ 07008

Tel.: (732) 750 3090  
Fax: (732) 750 3095

www.citylimestone.com  
info@citylimestone.com